

2 Contactors

Dimensions [mm (in)]

INDEX

BG... MINI-CONTACTORS WITH AC OR DC SUPPLY VOLTAGE

BG... three poles with screw terminals
and **RF...9** thermal overload relay

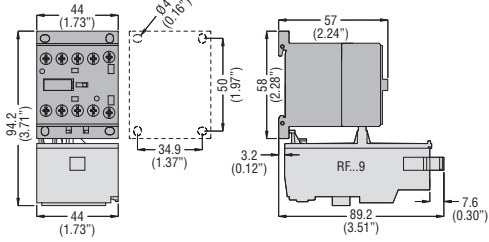

BG...T... four poles, with screw terminals

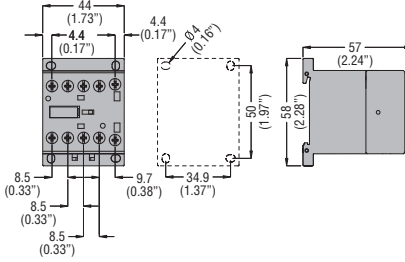

BGP... with rear PCB solder pins

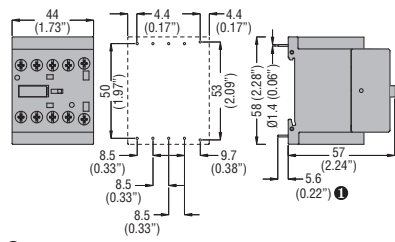

BGP... with Faston terminals

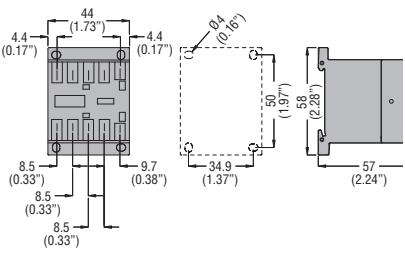

① Recommended PCB drillings 1.7-2mm.

BF... CONTACTORS WITH AC SUPPLY VOLTAGE

BF00A... BF09 A... - BF12A... - BF18A... - BF25A... three poles with **RF...38** thermal overload relay

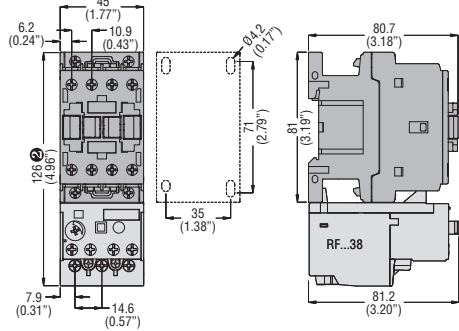

② 135mm/5.31" for RFE45

BF09T...A... - BF12T...A... - BF18T...A... four poles

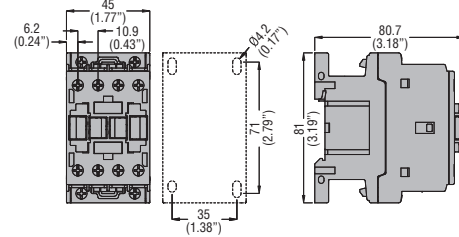

BF2600A... - BF3200A... - BF3800A... three poles with **RF...38** thermal overload relay

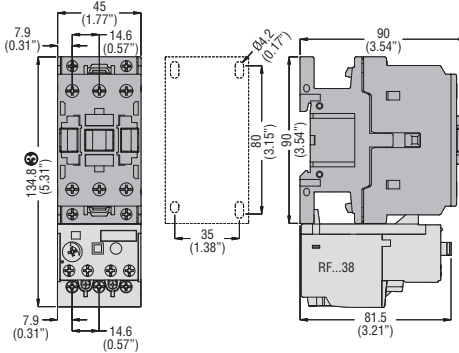

③ 144mm/5.67" for RFE45

BF26T...A... - BF38T...A... four poles

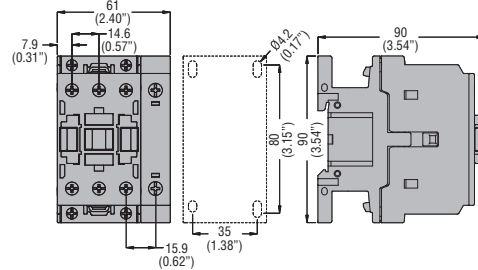

BF4000A... - BF5000A... - BF6500A... - BF8000A... - BF9400A... three poles with **RF82** thermal overload relay

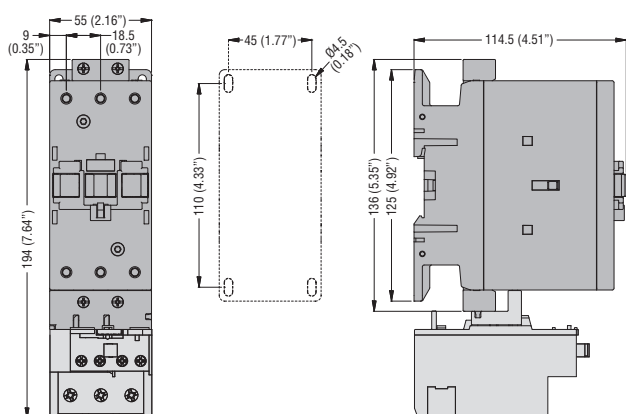

BF40T4...A... - BF50T4...A... - BF65T4...A... - BF80T4...A... - BFD80T4... - BF80T2A... four poles

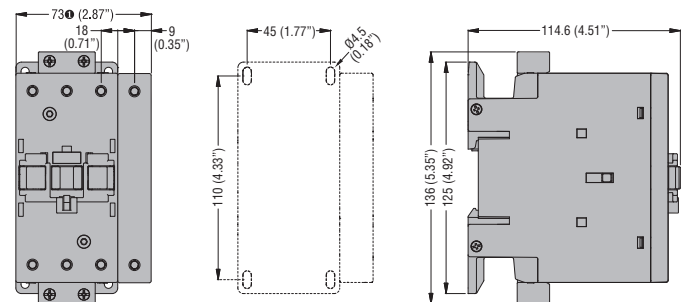

① BF80T2 91mm/3.58", BFD6500... 55mm/2.16"